

SONY®

Professional LCD Monitor

LUMA Family Catalog 2007



LUMA
Sony Professional LCD Monitor

A Comprehensive Line of – the Sony LUMA Series

Since its introduction in 2003, the Sony LUMA™ Series of professional LCD monitors has been offered in a variety of types and sizes, suiting applications in the studio and in the field. As a leading company in the HD CRT monitor market, Sony extends the LUMA Series by adding three new HD-compatible LCD monitors: the LMD-2450W, LMD-2050W, and LMD-2030W.

The high-grade one-piece type LMD-2450W and LMD-2050W incorporate a newly designed DSP (Digital Signal Processor) for high-end picture monitoring, while the entry-level one-piece type LMD-2030W offers a cost-effective solution for wedding and event videography applications.

■ Entry-level One-piece Type [Page 8](#)



■ Multi-display Type [Page 12](#)

True Professional LCD Monitors

All three monitors are SD/HD compatible, and the high-grade LUMA monitors accept PC signals via a digital DVI-D or an analog HD-15 interface. The high-grade LMD-2450W and LMD-2050W offer a variety of video interfaces up to HD-SDI, and the entry-level LMD-2030W accommodates an HDMI interface as standard.

At the same time, the LUMA Series continues to support the well-accepted Sony hand-held type and multi-display type monitors for a variety of picture monitoring needs and styles.

With the strength of Sony's video expertise, the Sony LUMA Series is sure to meet a variety of picture monitoring applications from broadcast and postproduction to medical and surveillance applications.

■ High-grade One-piece Type [Page 4](#)



■ Handheld Type [Page 10](#)

High-grade One-piece Type

The LMD-2450W and LMD-2050W are positioned at the top of the LUMA Series. They offer the latest DSP engine, the market-proven ChromaTRU™ color matching technology, and the high functionality for which Sony professional video monitors are renowned.

These monitors accept a variety signals in both analog and digital, and HD and SD formats.

Digital HD-SDI and SD-SDI interfaces are provided as options. The LMD-2450W and LMD-2050W are the best-suited LCD monitors in their class for broadcast and postproduction applications.

Two Panel Sizes

The high-grade one-piece type LUMA monitors are offered in two versions - the 24-inch LMD-2450W and the 20-inch LMD-2050W. (Viewable area measured diagonally.)

Model Types

	Panel Resolution	Panel Aspect Ratio	Panel Size*	Desktop Stand	Mounting Holes (mm)	
					19-inch Rack	VESA Mounting
LMD-2450W	1920 x 1200	Wide	24-inch	Supplied	–	100 x 100
LMD-2050W	1680 x 1050	Wide	20-inch	Supplied	Optional MB-529	100 x 100

* Viewable area measured diagonally.



LMD-2450W



LMD-2050W

Input Versatility

Multi-format Signal Support

The LMD-2450W and LMD-2050W both accept almost any SD or HD video format, both analog and digital. These include composite NTSC and PAL, component 480/60i and 575/50i, progressive 480/60P and 576/50P, and high-definition 1080/60i, 1080/50i, 720/60P, 1080/24P, 1080/25P, and 1080/30P. They also accept 1080/24PsF and 1080/25PsF. Standard interfaces include analog composite (NTSC/PAL), 525i/625i component and RGB, and Y/C. Additional inputs can be added by using option boards. Digital interfaces including HD-SDI and SD-SDI are also offered as optional boards, to meet budgetary and user needs. The LMD-2450W and LMD-2050W also accept various types of analog and digital computer signal via the standard HD-15 and DVI-D interfaces respectively. With their high-performance scan converters, these monitors can display PC signals from VGA to WUXGA*1.

*1 WUXGA images are not accepted by the LMD-2050W. Images ranging from WSXGA+ to 1920 x 1080 are down-converted for display on the LMD-2050W.

Input Signals/Input Adaptors

Video Signal Formats	Input Signal				Interface					
	Total Line	Active Line	Aspect Ratio	Frame rate*3	Composite Y/C	RGB Component	SDI 4:2:2	SD-SDI HD-SDI	Composite Y/C	RGB Component
					Standard	Optional BKM-220D	Optional BKM-243HS	Optional BKM-227W	Optional BKM-229X	
575/50i (PAL)	625	575	16:9 & 4:3	25	O	O	O	O	O	O
480/60i (NTSC)	525	483	16:9 & 4:3	30	O	O	O	O	O	O
576/50p	625	576	16:9 & 4:3	50	–	O	–	–	–	O
480/60p	525	483	16:9 & 4:3	60	–	O	–	–	–	O
1080/24PsF	1125	1080	16:9	24	–	O*2	–	O	–	O*2
1080/25PsF	1125	1080	16:9	25	–	O*2	–	O	–	O*2
1080/24p	1125	1080	16:9	24	–	O*2	–	O	–	O*2
1080/25p	1125	1080	16:9	25	–	O*2	–	O	–	O*2
1080/30p	1125	1080	16:9	30	–	O*2	–	O	–	O*2
1080/50i	1125	1080	16:9	25	–	O	–	O	–	O
1080/60i	1125	1080	16:9	30	–	O	–	O	–	O
720/50p	750	720	16:9	50	–	O*2	–	O	–	O*2
720/60p	750	720	16:9	60	–	O	–	O	–	O

*2 For component *3 Compatible with 1/1,001

LMD-2450W/LMD-2050W Connector Panel



LMD-2450W/LMD-2050W Option Slots



Signal-interface Options

The LMD-2450W and LMD-2050W accept HD-SDI and SD-SDI signals via the following optional input adaptors:

BKM-220D, SD-SDI 4:2:2 Input Adaptor*1

- SD-SDI signal input (x2)
- SD-SDI monitor output (x1)
- Power consumption: 1.5 W

*1 Embedded audio is supported.

BKM-243HS, HD-SDI/SD-SDI Input Adaptor*1

- HD-SDI/SD-SDI signal input (x2)
- HD-SDI/SD-SDI monitor output (x1)
- Power consumption: 2.0 W
- HD-SDI and SD-SDI signals are automatically detected

BKM-227W, NTSC/PAL Input Adaptor

- Composite input/output (x1)
- Y/C input/output (x1)
- Power consumption: 1.8 W

BKM-229X, Analog Component Adaptor

- RGB/ Y/PB/PR input connector (x3)
- EXT SYNC (x1)
- Power consumption: 4.0 W

Preset Computer Input Frequencies

The LMD-2450W and LMD-2050W are factory preset to accept 32 and 25 typical computer input signal frequencies respectively.

HD15 Input Signal Format

Resolution	H Total	H Addr.	V Total	V Addr.	Dot Clock [MHz]	fH [kHz]	fV [Hz]	Sync Polarity		LMD-2450W	LMD-2050W
								Horizontal	Vertical		
640x480 @60Hz	800	640	525	480	25.175	31.469	59.940	N	N	○	○
800x600 @56Hz	1024	800	625	600	36.000	35.156	56.250	P	P	○	○
800x600 @60Hz	1056	800	628	600	40.000	37.879	60.317	P	P	○	○
800x600 @72Hz	1040	800	666	600	50.000	48.077	72.188	P	P	○	○
800x600 @75Hz	1056	800	625	600	49.500	46.875	75.000	P	P	○	○
800x600 @85Hz	1048	800	631	600	56.250	53.674	85.061	P	P	○	○
1024x768 @60Hz	1344	1024	806	768	65.000	48.363	60.004	N	N	○	○
1024x768 @70Hz	1328	1024	806	768	75.000	56.476	70.069	N	N	○	○
1024x768 @75Hz	1312	1024	800	768	78.750	60.023	75.029	P	P	○	○
1024x768 @85Hz	1376	1024	808	768	94.500	68.677	84.997	P	P	○	○
1152x864 @75Hz	1600	1152	900	864	108.000	67.500	75.000	P	P	○	○
1280x960 @60Hz	1800	1280	1000	960	108.000	60.000	60.000	P	P	○	○
1280x1024 @60Hz	1688	1280	1066	1024	108.000	63.981	60.020	P	P	○	○
1600x1200 @60Hz	2160	1600	1250	1200	162.000	75.000	60.000	P	P	○	—
640x480 @60Hz	800	640	494	480	23.625	29.531	59.780	P	N	○	○
800x600 @60Hz	960	800	618	600	35.500	36.979	59.837	P	N	○	○
1024x768 @60Hz	1184	1024	790	768	56.000	47.297	59.870	P	N	○	○
1280x960 @60Hz	1440	1280	988	960	85.250	59.201	59.920	P	N	○	—
1600x1200 @50Hz	2144	1600	1235	1200	132.375	61.742	49.994	N	P	○	—
1600x1200 @60Hz	1760	1600	1235	1200	130.375	74.077	59.981	P	N	○	—
1360x768 @50Hz	1760	1360	791	768	69.500	39.489	49.922	N	P	○	○
1360x768 @60Hz	1776	1360	768	768	84.625	47.649	59.936	N	P	○	○
1360x768 @60Hz	1520	1360	790	768	72.000	47.368	59.960	P	N	○	○
1920x1080 @50Hz	2544	1920	1112	1080	141.375	55.572	49.975	N	P	○	○*
1920x1080 @60Hz	2080	1920	1111	1080	138.625	66.647	59.988	P	N	○	○*
1920x1200 @50Hz	2560	1920	1235	1200	158.000	61.719	49.975	N	P	○	—
1920x1200 @60Hz	2080	1920	1235	1200	154.125	74.099	59.999	P	N	○	—
1280x1024 @60Hz	1440	1280	1054	1024	91.000	63.194	59.957	P	N	○	○
1280x768 @50Hz	1648	1280	791	768	65.125	39.518	49.959	N	P	○	○
1280x768 @60Hz	1680	1280	795	768	80.125	47.693	59.992	N	P	○	○
1280x768 @75Hz	1712	1280	802	768	102.875	60.091	74.926	N	P	○	○
1280x768 @60Hz	1440	1280	790	768	68.250	47.396	59.995	P	N	○	○
720x400 @70Hz	900	720	449	400	28.322	31.469	70.087	N	P	○	○
1280x800 @60Hz					68.900	48.935	59.969	N	N	○	○
1920x1200 @60Hz	2120	1920	1212	1200	154.000	74.642	59.935	P	P	○	—

N = Negative P = Positive *down-converted to display

Connector Panel

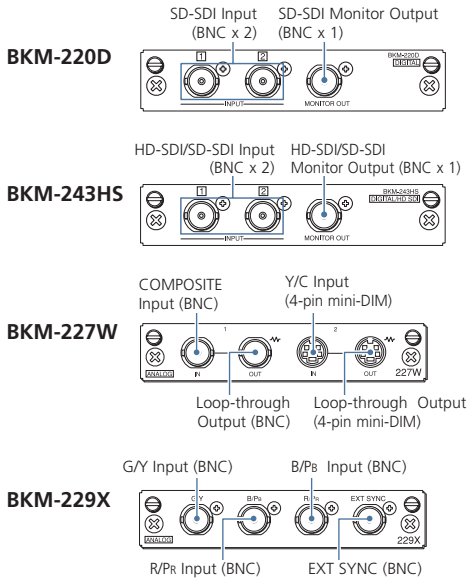

High-grade One-piece Type

Superb Picture Performance

High Purity Color Filters

The LMD-2450W and LMD-2050W use precisely manufactured RGB color filters, allowing the reproduction of colors with stunning depth and saturation to create highly natural images.

Accurate Gamma and Stable White Balance – ChromaTRU Color Processing



For an extra level of color reproduction accuracy, every LCD panel used in the LMD-2450W and LMD-2050W is precisely color calibrated at the factory, providing characteristics consistent with those of CRT displays.

The colorimetry of an LCD display, by nature, can exhibit inaccurate R, G, B color coordinates and unbalanced R, G, B gamma curves, which can make precise color matching between multiple monitors a challenge. These are also the primary reasons why LCD color tone can slightly differ from CRT tone.

The LMD-2450W and LMD-2050W solve this problem by precisely calibrating each LCD panel's light output so that the R, G, B color coordinates are virtually the same as those of a CRT monitor. A second calibration is further applied so that white balance is maintained at a consistent color temperature throughout all grayscale levels. The result of these precise calibrations is color reproduction reminiscent of Sony CRT displays.

CIE Color Coordinates

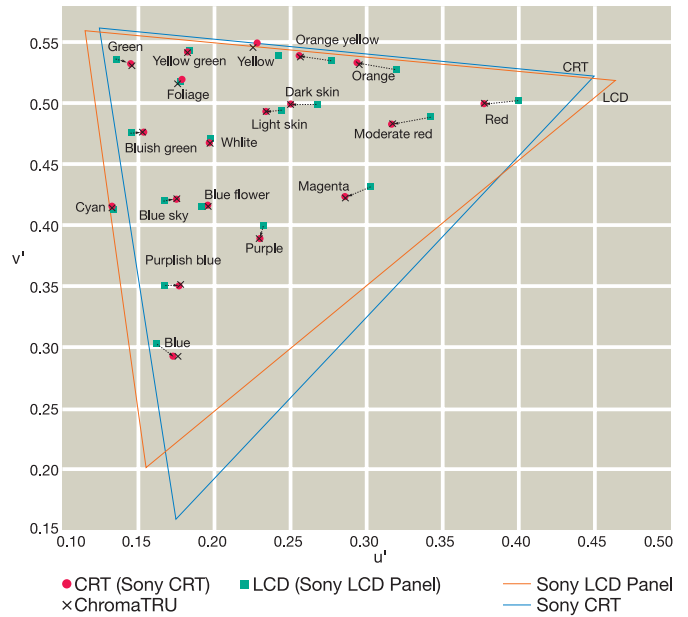

The CIE $u' v'$ chart is used to evaluate the light output of display devices. In this diagram, the raw light output of a Sony LCD panel is compared with that of a Sony CRT. The triangular areas show their different color reproduction capabilities (Color Space). The green and red dots indicate the color of light output from a Sony LCD panel and from a Sony CRT for certain RGB input signals. Note that the same light color is not obtained for the same video input. The ChromaTRU process, on the other hand, reproduces consistent light output extremely close to that of a CRT.

Sophisticated I/P Conversion

The LMD-2450W and LMD-2050W use a motion adaptive I/P conversion process to achieve conversion results that are optimized to the picture content - whether it is static or dynamic. Highly accurate I/P conversion is provided regardless of signal resolution, for example, whether the input is HD or SD.

Excellent Brightness and Contrast

The LMD-2450W and LMD-2050W both provide high-brightness, high-contrast images by utilizing super-wide aperture LCD panels.

Extremely Wide Viewing Angle

The LMD-2450W and LMD-2050W offer the most stable images within the LUMA Series when viewed from various angles. They offer a wide viewing angle of 178 degrees, horizontally and vertically, with virtually no reduction in picture contrast, color saturation, and hue shift. This allows precise images to be clearly viewed from various positions and angles – a critical requirement in professional video monitoring.



Operational Convenience

Advanced Marker Settings

These monitors can display various area markers, including a center marker, aspect markers, and a safety zone marker. The brightness of these markers can be selected from three different levels: white, gray, and dark gray. Users can also select either a black or gray matte to fill the outer area of the aspect markers. These flexible marker controls, together with the choice of many different aspect markers, make the LMD-2450W and LMD-2050W extremely convenient display devices for a variety of shooting scenarios – from standard video acquisition to digital cinematography.

Marker Variation

	16:9 Mode	4:3 Mode
Aspect Marker	4:3, 15:9, 14:9, 13:9, 1.85:1, 2.35:1, 1.85:1 & 4:3	16:9
Center Marker	○	
Safety Area	80%, 85%, 88%, 90%, 93%	

Color Temperature

Color temperatures of 9300k, or 6500k, or a user preset setting can be selected.

Selectable Scan Size for Video Input and Aspect Ratio

The scan size can be selected between 5% over scan and 0% scan modes. The aspect ratio can be switched between 16:9 and 4:3 according to the input signal.

Three-color Tally

The LMD-2450W and LMD-2050W come equipped with a tally lamp that can be lit via a parallel remote connector. The status of the signal displayed on the monitor can be identified by the tally color - red, green, or amber.

Smart APA (Auto Pixel Alignment) for Computer Input

The image size can be automatically adjusted to its optimal setting with the one-touch APA key.

Parallel Remote Control

The LMD-2450W and LMD-2050W can be controlled remotely via a parallel remote connector. There are 38 functions in the remote menu (such as the ability to switch input signals), of which eight can be allocated to the connector.

Stereo Audio Monitoring

The LMD-2450W and LMD-2050W are equipped with stereo speakers (0.5 W + 0.5 W), which enable the user to monitor audio.

Protected Controls

The key-inhibit function helps prevent inadvertent operation from the control panel.

Closed-Caption Decoder

The LMD-2450W and LMD-2050W are equipped with a closed caption decoder. The closed caption information embedded in the analog composite and component inputs can be decoded for display.

Convenient Installation

Mounting Flexibility

Mountable in a 19-inch EIA Standard Rack (LMD-2050W)

The LMD-2050W (8U high) can be rack mounted using the optional MB-529 Mounting Bracket, although wider than the 19-inch rack.

VESA Mounting

Complying with VESA standards, both the LMD-2450W and LMD-2050W can easily be mounted (100 x 100 mm pitch) on a wall or ceiling.

Other Features

- WFM and Audio* Level Meter Windows
 - * Only embedded audio is supported.
- Picture by Picture mode
- H/V Delay Function
- ACC Off
- DC Operation
- Setup Level for Analog Component and NTSC signal
- Sub Control on Contrast, Chroma, Phase, and Brightness
- Blue-Only Mode
- Monochrome Mode
- Auto Chroma/Phase Setup
- Serial Remote (Ethernet, RS-232C, Parallel Remote)
- DVI-D Input
- Power-saving Function (computer input only)
- DCC-2B

Entry-level One-piece Type

The LMD-2030W, LMD-1420 and LMD-1410 offer the best quality-per-cost balance for entry-level applications. The LMD-2030W can accept HD signals via its HDMI interface or analog component connectors. The LMD-1420 and LMD-1410 are exclusively designed for SD monitoring. All of these models provide the user-friendly features proven in Sony professional monitors for convenient monitoring in wedding and event videography, and many other applications.

Two Panel Sizes

The entry-level one-piece type LUMA monitors are offered in three versions: the LMD-1410 which provides the basic features for SD professional picture monitoring, the LMD-1420 for more advanced SD monitoring, and the LMD-2030W with an HD monitoring capability.

Model Types

	Panel Resolution	Panel Aspect Ratio	Panel Size*	Desktop Stand	Mounting Holes (mm)	
					19-inch Rack	VESA Mounting
LMD-2030W	1680 x 1050	Wide	20-inch	Supplied	Optional MB-529	100 x 100
LMD-1410	640 x 480	4:3	14-inch	Supplied	Optional MB-526	100 x 100
LMD-1420	640 x 480	4:3	14-inch	Supplied	Optional MB-526	100 x 100

* Viewable area measured diagonally.



LMD-2030W



LMD-1420



LMD-1410

Input Versatility

All entry-level one-piece type LUMA monitors come equipped with a full range of analog SD inputs including analog composite NTSC and PAL, Y/C (S-Video), and 525i/625i component and RGB.

The LMD-2030W and LMD-1420 further handle SD-SDI input by using the optional BKM-320D SD-SDI input adaptor. Furthermore, the LMD-2030W offers an HD signal input capability via its standard HDMI and Analog Component interface.

	Interface			
	Composite/Y/C	RGB/Component	SD-SDI	HDMI
LMD-2030W	○	○	Optional BKM-320D	○
LMD-1410	○	○		—
LMD-1420	○	○	—	—

Model	Input Signal			Interface			
	Total Line	Active Line	Aspect Ratio	Composite Y/C	RGB Component	SD-SDI	HDMI
				Standard	Standard	Optional BKM-320D	Standard
				LMD-2030W	LMD-2030W	LMD-2030W	LMD-2030W
				LMD-1420	LMD-1420	LMD-1420	LMD-1410
				LMD-1410	LMD-1410		
575/50i (PAL)	625	575	16:9/4:3	○	○	○	○*3
480/60i (NTSC)*1	525	483	16:9/4:3	○	○	○	○*4
576/50P	625	576	16:9/4:3	—	○	—	○
480/60P	525	483	16:9/4:3	—	○	—	○
1080/24PsF*1	1125	1080	16:9	—	○*2	—	—
1080/25PsF	1125	1080	16:9	—	○*2	—	—
1080/24P*1	1125	1080	16:9	—	○*2	—	○
1080/25P	1125	1080	16:9	—	○*2	—	○
1080/30P*1	1125	1080	16:9	—	○*2	—	○
1080/50i	1125	1080	16:9	—	○*2	—	○
1080/60i*1	1125	1080	16:9	—	○	—	○
720/50P	750	720	16:9	—	○*2	—	○
1080/60P*1	750	720	16:9	—	○	—	○

*1 The frame rate is also compatible with 1/1,001 frame rates.

*2 Component signals only.

*3 720 (1440) x 576i @ 50 Hz.

*4 720 (1440) x 480i @ 59.94/60 Hz.

Entry-level One-piece Type

LMD-2030W Connector Panel

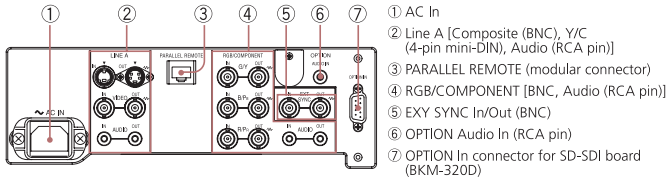

LMD-1420 Connector Panel

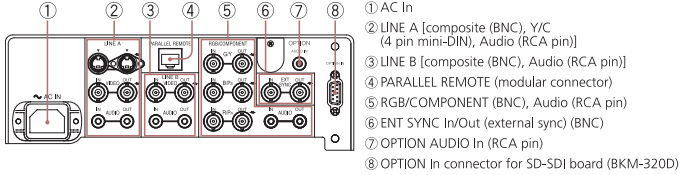

LMD-1410 Connector Panel

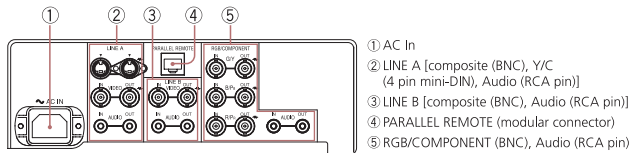

High Picture Performance

High Purity Color Filters

The entry-level one-piece type LUMA monitors come equipped with high-purity RGB color filters, allowing the reproduction of colors with stunning depth and saturation.

Excellent Brightness and Contrast

The entry-level one-piece type LUMA monitors provide high-brightness, high-contrast images.

Wide Viewing Angle

The LCD panels used in the entry-level one-piece type LUMA monitors provide a wide viewing angle of 178 degrees for the LMD-2030W, and 170 degrees for the LMD-1420 and LMD-1410, both horizontally and vertically, with minimal reduction in picture contrast. This allows images to be viewed from various positions and angles.

Operational Convenience

Advanced Marker Settings

The LMD-2030W and LMD-1420 can display various area markers, including a center marker and aspect markers. The brightness of these markers can be selected from three different levels: white, gray, and dark gray. Users can also select either a black or gray matte to fill the outer area of the aspect markers. These flexible marker controls, together with the choice of many different aspect markers, make these monitors extremely convenient display devices for a variety of shooting scenarios.

Marker Variation

		16:9 Mode	4:3 Mode
Aspect Marker	LMD-2030W	4:3	16:9
	LMD-1420	4:3, 15:9, 14:9, 13:9	
Center Marker	LMD-2030W LMD-1420	○	
Safety Area	LMD-1420	80%, 85%, 88%, 90%, 93%	

Color Temperature

The color temperature can be selected as 'high', 'low', or user preset.

Selectable Scan Size for Video Input and Aspect Ratio

The scan size can be selected between 5% over-scan and -3% underscan modes. The aspect ratio can be switched between 16:9 and 4:3 according to the input signal.

Three-color Tally

The LMD-2030W and LMD-1420 come equipped with a tally lamp that can be lit via a parallel remote connector. The status of the signal displayed on the monitor can be identified by the tally color - red, green, or amber.

Parallel Remote Control

The entry-level one-piece type LUMA monitors can be controlled remotely via their parallel remote connectors. In the remote menu, there are 17 functions for the LMD-2030W and 25 for the LMD-1420 and LMD-1410 (such as the ability to switch input signals), of which seven can be allocated to the remote connector.

Monaural Audio Monitoring

All entry-level one-piece type LUMA monitors are equipped with a speaker (0.5 W), which enables the user to monitor audio.

Protected Controls

The key-inhibit function helps prevent inadvertent operation from the control panel.

Convenient Installation

Mounting Flexibility

Mountable in a 19-inch EIA Standard Rack (LMD-2030W)

All entry-level one-piece type LUMA monitors can be mounted in a 19-inch EIA standard rack using optional mounting brackets. The 9U-high LMD-2030W uses the MB-529 Mounting Brackets, and the 7U-high LMD-1420 and LMD-1410 use the MB-526 Mounting Brackets.

VESA Mounting

Complying with VESA standards, these monitors can easily be mounted (100 x 100 mm pitch) on a wall or ceiling.

Other Features

- Setup Level for Analog Component and NTSC signals
- Blue-Only Mode (LMD-2030W and LMD-1420 only)
- External Sync IN (LMD-2030W and LMD-1420 only)
- 4:3 Zoom (LMD-1420 only)

Handheld Type

The handheld type LUMA monitors offer a great level of monitoring convenience in the field and the studio. Three models are available – the LMD-9050 with digital HD-SDI and SD-SDI input capability the LMD-9030 focusing on SD-SDI video monitoring, and the LMD-9020, exclusively for analog video monitoring. All three models can display HD images using their analog component inputs. Incorporating high-purity 9-inch* panels, these monitors can be AC, DC, or battery driven so that they can be hand-held, situated on a desk, or mounted in standard racks. * 8.4-inch viewable area measured diagonally.



LMD-9050



LMD-9030



LMD-9020

Panel Type

	Panel Aspect Ratio	Panel Size*	Acceptable Format
LMD-9050	4:3	8.4-inch	Analog, HD-SDI/SD-SDI
LMD-9030	4:3	8.4-inch	Analog, SD-SDI
LMD-9020	4:3	8.4-inch	Analog

* Viewable area measured diagonally.

Input Versatility

To keep their units simple and clean, the handheld type LUMA monitors provide all inputs built-in as standard, instead of using optional input modules. For typical SD video monitoring, all three monitors offer interfaces for analog composite (NTSC/PAL), analog component/RGB (525/60i and 625/50i) and analog Y/C (S-Video). The LMD-9030 additionally offers SD-SDI input capability. The top-of-the-line LMD-9050 further provides a variety of digital progressive SD and HD formats through its HD-SDI interface*. These include 480/60P and 576/50P, and high-definition 1080/60i, 1080/50i, 720/50P, 720/60P as well as 1080/24PsF.

* The SD-SDI and HD-SDI inputs share the same BNC connectors, which offer automatic signal-type detection.

Input Signals

System	Input Signal			Standard Interface			
	Total Lines	Active Line	Aspect Ratio	Composite Y/C (x 1)	RGB Component (x 1)	SDI (x2)	
	Model			LMD-9050 LMD-9030 LMD-9020	LMD-9050 LMD-9030 LMD-9020	LMD-9050 LMD-9030	LMD-9050
575/50i	625	575	16:9/4:3	0	0	0	—
480/60i*	525	483	16:9/4:3	0	0	0	—
480/60P	525	483	16:9/4:3	—	0	—	—
576/50P	625	576	16:9/4:3	—	0	—	—
1080/24PsF	1125	1080	16:9	—	0	—	0
1080/50i	1125	1080	16:9	—	0	—	0
1035/60i*	1125	1035	16:9	—	0	—	0
1080/60i*	1125	1080	16:9	—	0	—	0
720/50P	750	1080	16:9	—	0	—	0
720/60P	750	720	16:9	—	0	—	0

* Also accepts 59.94 Hz field rate.

High Picture Quality

Excellent Brightness and Contrast

The handheld type LUMA monitors provide high-brightness and high-contrast images by using wide aperture LCD panels. In addition, the use of precisely manufactured RGB color filters allows these monitors to reproduce colors with stunning depth and saturation – creating highly natural images.

Wide Viewing Angle

The LCD panels used in the handheld type LUMA monitors have a wide viewing angle of 170 degrees, both horizontally and vertically, with minimal reduction in picture contrast.

AR (anti-reflection) Coated Protection Panel

The handheld type LUMA monitors use robust AR-coated protection layers, which minimize the chance of their panels being scratched during transportation – an extremely important criteria for use in the field or in any mobile application. The AR coating additionally has two unique characteristics: it provides a high transmission rate of the internal light source to keep the picture as bright as possible, and it keeps reflection from ambient light to a minimum. As a result, when used in bright lighting conditions, high contrast is still maintained even in dark areas of the picture.

Operational Convenience

ENG Kit VF-509

The handheld type LUMA monitors are a strategic choice for use in ENG and EFP field operations. When compared to CRT displays, the picture contrast of these monitors is affected less by ambient light, allowing clear images to be viewed even under strong sunlight. For further protection, the optional VF-509 ENG kit provides a Viewing Hood, Carrying Handle, and Connector Protector.

4:3/16:9 Switchable Display

The scan aspect ratio can be switched between 4:3 and 16:9.

Selectable Scan Size

The scan size can be selected between 5% over-scan, 0%, and -3% underscan modes.

LMD-9050, LMD-9030 and LMD-9020 Connector Panel

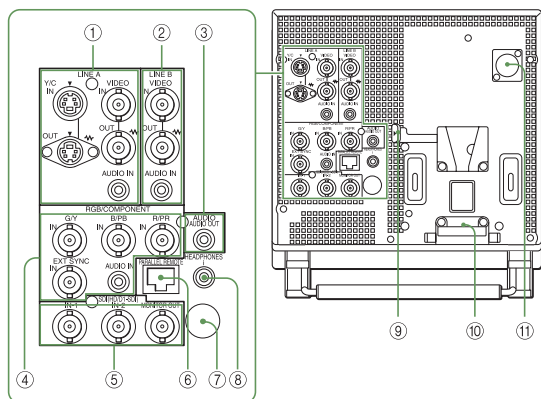

- ① Line A
 - Y/C In/Out (4-pin mini-DIN x 2)
 - Composite In/Out (BNC x 2)
 - Audio in (mini jack x 2)
- ② Line B
 - Composite In/Out (BNC x 2)
 - Audio In (mini jack)
- ③ Audio Out (mini jack)
- ④ RGB/Component
 - G/Y, B/Pb, R/Pr In (BNC x 3)
 - EXT Sync (BNC)
 - Audio In (mini jack)
- ⑤ SDI In/Out
 - (LMD-9050 : HD-SDI/SD-SDI In/Out)
 - (LMD-9030 : SD-SDI In/Out)
 - SDI-In (BNC x 2)
 - Monitor Out (BNC)
- ⑥ Parallel Remote (modular 8-pin)
- ⑦ Service Terminal
- ⑧ Headphones Jack
- ⑨ AC Adaptor Eject
- ⑩ AC Adaptor Attachment place
- ⑪ DC 12V In (XLR-type 4-pin)

Advanced Marker Settings

The handheld type LUMA monitors can display various area markers, including a center marker and aspect markers. The brightness of these markers can be selected from three different levels, white, gray, and dark gray, and their widths can be selected from FINE, STANDARD, and BOLD. Users can also select either a black or gray matte to fill the outer area of the aspect markers. These flexible marker controls, together with the choice of many different aspect markers, make the handheld type LUMA monitors extremely convenient for a variety of shooting scenarios.

	16:9 Mode	4:3 Mode
Aspect Marker	4:3, 15:9, 14:9, 13:9, 1.85:1, 2.35:1, 1.85:1 & 4:3	16:9
Center Marker	O	

Color Temperature/Gamma Selection

High/low color temperatures or user preset can be selected. A variety of gamma modes can also be selected.

Three-color Tally

All handheld type LUMA monitors come equipped with a tally lamp that can be lit up via a parallel remote connector. The status of the signal displayed on the monitor can be identified by the tally color – red, green, or amber.

Parallel Remote Control

The handheld type LUMA monitors can be controlled remotely via their parallel remote connectors. There are 27 functions in the remote menu (such as the ability to switch input signals), of which seven can be allocated to the connector.

Monaural Audio Monitoring

All handheld type LUMA monitors are equipped with a speaker (0.5 W), which enables the user to monitor audio.

Protected Controls

The key-inhibit function helps prevent inadvertent operations from the control panel.

Convenient Installation

Mounting Flexibility

The handheld type LUMA monitors are 5U high and half-rack wide. Using the optional MB-525 Mounting Bracket with a nine-step tilt capability, two units can be installed side-by-side in a 19-inch EIA standard rack.

Other Features

- Setup Level for Analog Component and NTSC signal
- Sub Control on Contrast, Chroma, Phase, and Brightness
- Blue-only mode
- Power-saving Function
- Monochrome mode
- 4:3 Zoom

Multi-display Type

The multi-display type LUMA monitors integrate high-quality LCD panels into an extremely thin and lightweight, 19-inch rack-mountable chassis. They can be AC or DC powered. These monitors are particularly handy for viewing multiple SD signal sources in space-confined environments – such as OB vehicles, machine rooms, and desktops – or any general application where multiple pictures must be viewed.



LMD-7220W



LMD-5320



LMD-4420

LMD-7220W Connector Panel

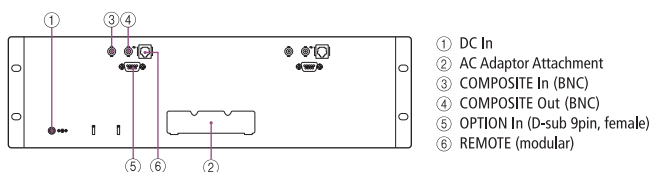

LMD-5320 Connector Panel

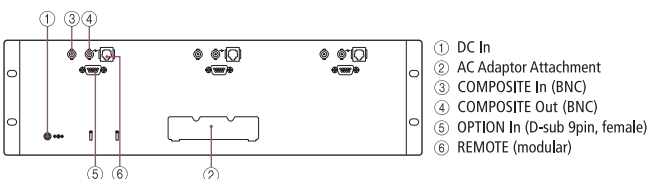

LMD-4420 Connector Panel

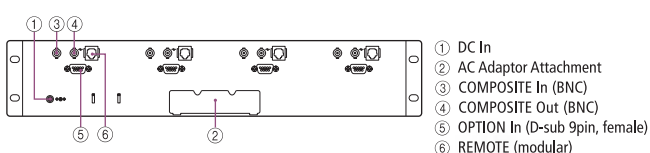

Panel Types

	Panel Aspect Ratio	Number of Displays	Display Size* ¹
LMD-4420	4:3	4	4-inch
LMD-5320	4:3	3	5.6-inch
LMD-7220W	16:9* ²	2	7-inch

*¹ Viewable area measured diagonally.

*² HD signals must be externally down-converted for display.

Input Capability

All multi-display type LUMA monitors accept either composite or SDI signals. Each LCD panel is equipped with a composite connector as standard, while SDI input can be added simply by installing the optional BKM-320D*.

* One BKM-320D is required per screen.

High Picture Quality

Although small in size, the multi-display type LUMA monitors incorporate high-grade LCD panels with high brightness and high contrast. These LCD panels also offer a wide viewing angle, both vertically and horizontally.

Operational Convenience

Selectable Aspect Ratio (LMD-7220W only)

The scan aspect ratio of the displays on the LMD-7220W can be switched between 16:9 and 4:3 by pressing a button on the front panel.

Three-color Tally

The LMD-7220W, LMD-5320, and LMD-4420 come equipped with a tally lamp that can be lit up via a parallel remote connector. The status of the signal displayed on the monitor can be identified by the tally color – red, green, or amber.

Parallel Remote Control

The multi-display type LUMA monitors can be controlled remotely via their parallel remote connector. There are 5 functions (LMD-7220W)/4 functions (LMD-5320/LMD-4420) in the remote menu (such as the ability to switch input signals), which can be allocated to the connector.

Low Power Consumption

Compared to conventional CRT multiple monitors, multi-display type LUMA monitors offer drastic reductions in power consumption and room-cooling requirements. This is a huge bonus in applications where power consumption is critical, such as OB van installations.

Slim and Light

Thanks to their thin and lightweight designs, the multi-display type LUMA monitors are ideal for installations where space is limited.

Convenient Installation

All multi-display type LUMA monitors are mountable on a 19-inch EIA standard rack. For viewing convenience, the LMD-7220W and LMD-5320 offer a 5-step tilt mechanism, and the LMD-4420 offers a 3-step tilt mechanism.

Optional Accessories



- **BKM-220D**
SD-SDI 4:2:2 Input Adaptor
(for LMD-2450W and LMD-2050W)



- **BKM-243HS**
HD-SDI/SD-SDI Input Adaptor
(for LMD-2450W and LMD-2050W)



- **BKM-227W**
NTSC/PAL Input Adaptor
(for LMD-2450W and LMD-2050W)



- **BKM-229X**
Analog Component Adaptor
(for LMD-2450W and LMD-2050W)



- **BKM-320D**
SD-SDI Input Adaptor
(for LMD-2030W, LMD-1420, LMD-7220W, LMD-5320, and LMD-4420)



- **MB-526**
Mounting Bracket
(for LMD-1420 and LMD-1410)



- **MB-529**
Mounting Bracket
(for LMD-2050W and LMD-2030W)



- **MB-525**
Mounting Bracket
(for LMD-9050, LMD-9030 and LMD-9020)



- **MB-528**
Mounting Panel
(for LMD-9050, LMD-9030 and LMD-9020)



- **VF-509**
ENG Kit (Viewing Hood, Carrying Handle and Connector Protector)
(for LMD-9050, LMD-9030 and LMD-9020)



- **BC-L80S**
Lithium-ion Battery Charger



- **BC-L60S**
Lithium-ion Battery Charger



- **BP-GL95/BP-GL65**
Rechargeable Lithium-ion Battery Pack



- **BC-L70**
Lithium-ion Battery Charger

Feature Comparison

	High-grade One-piece Type		Entry-level One-piece Type		
	LMD-2450W	LMD-2050W	LMD-2030W	LMD-1420	LMD-1410
Monitor System					
Picture Resolution	1920 x 1200 pixels	1680 x 1050 pixels	1680 x 1050 pixels	640 x 480 pixels	
Picture Size	24-inch	20-inch	20-inch	14-inch	
LCD Panel	A-Si TFT Active Matrix		a-Si TFT Active Matrix		
Acceptable computer system	upto WUXGA	upto WSXGA+	No		
Panel aspect Ratio	16:10		16:10	4:3	
Protection Panel/AR Coating	No		No	Yes	No
16:9 Capability	Yes		Yes		
HD/SD	HD (analog/digital)/SD (analog/digital)		HD (analog/digital)/SD (analog/digital)	HD (analog)/SD (analog/digital)	HD (analog)/SD (analog)
Composite Video Input/Output	Yes		Yes		
Y/C Input/Output	Yes		Yes		
Component (Y,R-Y,B-Y)/RGB Input	Yes		Yes		
SD-SDI video input	Yes		1x (with BKM-320D)		No
HD-SDI video input	Yes		No		
SDI with Audio decoding	Yes		No		
Computer Input	Yes		No		
HDMI	No		Yes	No	
Audio Input/Output	Yes		Yes		
External Sync Input/Output	Yes		Yes		No
EIA 19-inch Rack Mounting	No	MB-529	MB-529	MB-526	
VESA Mounting	Yes		Yes		
Desk-top Stand	Supplied Stand		Stand supplied		
Overscan	Yes		Yes		
Color Temperature	Selectable		Selectable		
Blue Only	Yes		Yes	No	
H/V delay	Yes		No		
Tally	3-Color		3-Color		No
Area Marker	Yes		No	Yes	No
Li-Ion battery Operation	No		No		
DC Operation	No		No		

	Handheld Type			Multi-display Type		
	LMD-9050	LMD-9030	LMD-9020	LMD-7220W	LMD-5320	LMD-4420
Monitor System						
Picture Resolution	1024 x 768 pixels	640 x 480 pixels		480 x 234 pixels	481 x 234 pixels	482 x 234 pixels
Picture Size	8.4-inch			2x7-inch	3x5.6-inch	4x4-inch
LCD Panel	a-Si TFT Active Matrix			a-Si TFT Active Matrix		
Acceptable computer system	No			No		
Panel Aspect Ratio	4:3			16:9	4:3	
Protection Panel/AR Coating	Yes			No		
16:9 Capability	Yes			Yes	No	
HD/SD	HD (analog/digital)/SD (analog/digital)	HD (analog)/SD (analog/digital)	HD (analog)/SD (analog)	HD (analog)/SD (analog/digital)		
Composite Video Input/Output	Yes			Yes		
Y/C Input/Output	Yes			No		
Component (Y,R-Y,B-Y)/RGB Input	Yes			No		
SD-SDI Video Input	2xHD or SD Auto detectable	Yes	No	Yes (with BKM-320D)		
HD-SDI Video Input		No	No	No		
SDI with Audio decoding	Yes		No	No		
Computer Input	No			No		
HDMI	No			No		
Audio Input/Output	Yes			No		
External Sync Input/Output	Yes			No		
EIA 19-inch Rack Mounting	MB-525			Supplied		
VESA Mounting	No			No		
Desk-top Stand	Stand supplied			Not applicable		
Overscan	Yes			No		
Color Temperature	Selectable			Selectable		
Blue Only	Yes			No		
H/V delay	No			No		
Tally	3-Color			3-Color		
Area Marker	Yes			No		
Li-Ion Battery Operation	Yes			No		
DC Operation	Yes			Yes		

Specifications

High-grade One-piece Type



LMD-2450W



LMD-2050W

Picture Performance		
Type	A-Si TFT Active Matrix LCD	A-Si TFT Active Matrix LCD
Resolution	1920 x1200 pixels (WUXGA)	1680 x1050 pixels (WSXGA+)
Picture Size (H x W) (Viewable area) (Diagonal)	Approx. 518.4 x 324.0 mm (Approx. 20 1/2 x 12 1/8 inches) Approx. 609.6 mm (24 inches)	Approx. 433.5 x 272.9 mm (Approx. 17 1/8 x 10 3/4 inches) Approx. 511.1 mm (20 1/8 inches)
Aspect	16:10	
Colors	Approx 1,677,000 colors (8bits)	
Viewing Angle	89°/89°/89°/89° (typical) (up/down/left/right contrast>10:1)	
Input		
Standard	Composite BNC x 1, 1.0 Vp-p ±3dB sync negative	
Y/C	4pin Mini DIN x 1 Y: 1.0 Vp-p ±3dB sync negative, C: 0.286 Vp-p ±3dB (NTSC burst signal level), 0.3 Vp-p ±3dB (PAL burst signal level)	
RGB, Component	BNC x 3 RGB : 0.7 Vp-p ±3dB (Sync On Green, 0.3 Vp-p sync negative) Component : 0.7 Vp-p ±3dB (75% chrominance standard color bar signal)	
External Sync	BNC x 1 0.3 to 4.0 Vp-p ± bipolarity ternary or negative polarity binary	
Audio	RCA pin x 2 (L, R) -5 dBu 47 k Ω or higher	
HD15	D-sub 15 pin x 1, R/G/B: 0.7 Vp-p sync positive (Sync On Green, 0.3 Vp-p sync negative) Sync : Total level (polarity free, H/V separate and composite sync) Plug & Play function : corresponds to DDC-2B	
DVI	TMDS signal link	
Parallel remote	Modular connector 8 pin x 1 (pin assignment at users' allocation)	
Serial remote (LAN)	D-sub 9-pin (RS232C) x 1, RJ-45 modular connector (ETHERNET) x 1 (10BASE-T/100BASE-TX)	
DC in	XLR type 4pin x 1 DC24V (output impedance 0.005 Ω or less)	
Optional	Option input slot 2 slots (for HD-SDI, SDI capability and extra analog I/O's)	
Output		
Standard	Composite BNC x 1, Loop-though, with 75 Ω automatic termination	
Y/C	4pin mini DIN x 1 Loop-though, with 75 Ω automatic termination	
RGB, Component	BNC x 3, Loop-though, with 75 Ω automatic termination	
External Sync	BNC x 1, Loop-though, with 75 Ω automatic termination	
Audio monitor out	RCA pin type x 2 (L, R)	
Speaker (Built-in)	1 W + 1 W (stereo)	
General		
Power Requirement	AC100V to 240V 50/60Hz 0.6A to 1.1A, DC24V 4.6A	AC100V to 240V 50/60Hz 0.4A to 0.8A, DC24V 3.3A
Power Consumption	Maximum Approx. 115 W (with 2 x BKM-229X)	Maximum Approx. 95 W (with 2 x BKM-229X)
Operating Temperature	0 to 35 °C (recommended operation temperature 20 to 30 °C)	
Operating Humidity	30 to 85% (No condensation)	
Storage & Transport Temperature	-20 to 60 °C	
Storage & Transport Humidity	0 to 90 %	
Operating/Storage/Trans. Pressure	700 to 1060 hPa	
Dimensions (W x H x D)		
Dimension	602.4 x 497.9 x 269.9 mm (23 3/4 x 19 3/8 x 10 3/4 inch)	518.5 x 468.4 x 269.9 mm (20 1/2 x 18 1/2 x 10 3/4 inch)
Dimension without stand	602.4 x 386.2 x 110.0 mm (23 3/4 x 15 1/4 x 4 3/8 inch)	518.5 x 328.7 x 104.7 mm (20 1/2 x 13 x 4 1/8 inch)
Display Stand (W x H x D)	320.0 x 361.5 x 269.9 mm (12 5/8 x 14 1/4 x 10 3/4 inches)	
Mass	With two option boards Approx. 11.4 kg (25 lb 2 oz) with BKM-229X x 2	Approx. 10.5 kg (23 lb 2 oz) with BKM-229X x 2
	Without option boards Approx. 11.0 kg (24 lb 4 oz)	Approx. 10.1 kg (22 lb 4 oz)

Dimensions

LMD-2450W

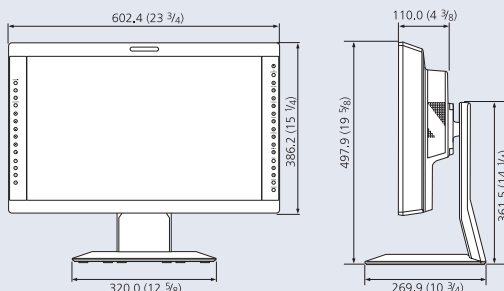

LMD-2050W

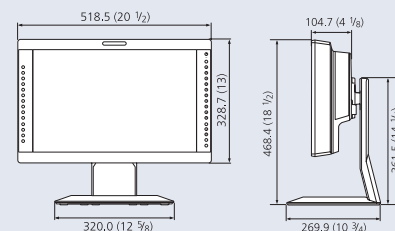

Unit: mm (inches)

Specifications

Entry-level One-piece Type



Picture Performance			
Type	A-Si TFT Active Matrix LCD	A-Si TFT Active Matrix LCD with a multi-layer AR-coated protection panel	A-Si TFT Active Matrix LCD
Resolution	1680 x 1050 pixels (WSXGA+)		640 x 480 pixels (VGA)
Picture Size (H x W) (Viewable area) (Diagonal)	Approx. 433 x 271 mm (Approx. 17 1/8 x 10 3/4 inches) Approx. 511 mm (20.1-inch)		Approx. 283 x 212 mm (Approx. 11 1/4 x 8 3/8 inches) Approx. 354 mm (14-inch)
Aspect	16:10		4:3
Colors	Approx. 16,700,000		Approx. 16,200,000 colors
Viewing Angle	89°/89°/89°/89° (typical) (up/down/left/right contrast>10:1)		85°/85°/85°/85° (typical) (up/down/left/right contrast>10:1)
Input			
Line A	Composite	BNC x 1, 1.0 Vp-p ±3dB, sync 0.3 Vp-p negative	
	Y/C	4-pin mini-DIN x 1 Y: 1.0Vp-p ±3 dB C: 0.286 Vp-p ±3 dB (NTSC), 0.3 Vp-p ±3 dB (PAL), sync 0.3 Vp-p negative	
	Audio in	RCA pin x 1, -5 dBu 47 Ω or higher	
Line B	Composite	–	BNC x 1, 1.0 Vp-p ±3dB, sync 0.3 Vp-p negative
	Audio in	–	RCA pin x 1, -5 dBu 47 Ω or higher
RGB/Component			
RGB/Component		BNC x 3, 0.7 Vp-p ±3 dB (Sync on Green 0.3 Vp-p, negative: RGB) (75% chrominance standard color bar signal: Component)	
	Audio in	RCA pin x 1, -5 dBu 47 kΩ or higher	
Option	D1-SDI	D-sub 9-pin x 1	–
	Audio in	AUDIO input (RCA pin x1), -5 dBu 47 kΩ or higher	
External Sync		BNC x1, 0.3 to 4 Vp-p negative polarity binary	
HDMI input	HDMI x 1		–
Remote	Parallel remote		Modular connector 8-pin x 1
Output			
Line A	Composite	BNC x 1, Loop-through, with 75 Ω automatic termination	
	Y/C	DIN 4 pin x 1, Loop-through, with 75 Ω automatic termination	
	Audio out	RCA pin x1, Loop-through	
Line B	Composite	–	BNC x 1, Loop-through, with 75 Ω automatic termination
	Audio out	–	RCA pin x 1, Loop-through
RGB/Component			
RGB/Component		BNC x3, Loop-through, with 75 Ω automatic termination	
	Audio out	RCA pin x 1, Loop-through	
External Sync		BNC x1, Loop-through, with 75 Ω automatic terminal function	
Built-in speaker output		0.5 W (mono)	
General			
Power Consumption	Approx. 72 W	Approx. 51 W	Approx. 48 W
Power requirement	AC100 to 240V, 50/60 Hz		
Operating Temperature	0 to 35 °C (recommended operation temperature 20 to 30 °C)		
Operating Humidity	30 to 85% (No condensation)		
Storage & Transport Temperature	-20 to 60 °C		
Storage & Transport Humidity	0 to 90 %		
Operating/Storage/Trans. Pressure	700 to 1060 hPa		
Dimensions (W x H x D)			
Dimension	Approx. 493 x 408 x 264 mm (19 1/2 x 16 1/8 x 10 1/2 inch)	Approx. 343 x 354 x 264 mm (13 5/8 x 14 x 10 1/2 inch)	Approx. 343 x 354 x 264 mm (13 5/8 x 14 x 10 1/2 inch)
Dimension without stand	Approx. 493 x 361 x 87mm (19 1/2 x 14 1/4 x 3 1/2 inch)	Approx. 343 x 304 x 87mm (13 5/8 x 12 x 3 1/2 inch)	Approx. 343 x 304 x 87mm (13 5/8 x 12 x 3 1/2 inch)
Mass	Panel & Stand	Panel & Stand	Panel & Stand
	Approx. 9.6 kg (21.2 lb 3 oz)	Approx. 6.8 kg (14 lb 16 oz)	Approx. 6.5 Kg (14 lb 5 oz)
	Panel only	Panel only	Panel only
	Approx. 7.9 kg (17 lb 6 oz)	Approx. 5.1 kg (11 lb 4 oz)	Approx. 4.8 kg (10 lb 9 oz)
Supplied Accessories	Display Stand, AC power cord, AC plug holder, Operating Instructions, CD-ROM, Using the CD-ROM Manual, Warranty Card		

Dimensions

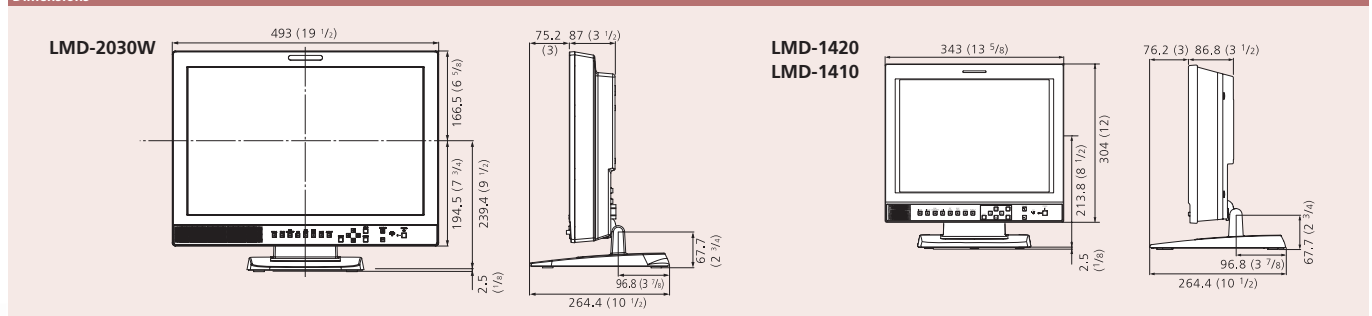

Unit: mm (inches)

Handheld Type



Picture Performance				
Type	a-Si TFT Active Matrix LCD with a multi-layer AR-coated protection panel			
Resolution	1024 x 768 pixels	640 x 480 pixels		
Picture Size (H x W), (Viewable area) (Diagonal)	Approx. 170.5 x 127.9 mm, (Approx. 6 3/4 x 5 1/8 inches) Approx. 213 mm (8.4-inch)	Approx. 170.9 x 128.2 mm, (Approx. 6 3/4 x 5 1/8 inches) Approx. 213.6 mm (8.4-inch)		
Aspect	4:3			
Colors	16,770,000 colors			
Viewing Angle	85°/85°/85°/85° (typical) (up/down/left/right contrast>10:1)			
Input				
Line A	Composite	BNC x 1, 1.0 Vp-p +3dB, -6 dB sync negative		
	Y/C	4-pin mini-DIN x 1 Y : 1.0 Vp-p + 3dB, -6 dB sync negative C : 0.286 Vp-p ±3 dB (NTSC), 0.3 Vp-p ±3 dB (PAL)		
	Audio	Mini jack x 1, -5 dBu 47 kΩ or higher		
Line B	Composite	BNC x 1, 1.0 Vp-p +3 dB, -6 dB sync negative		
	Audio	Mini jack x 1, -5 dBu 47 kΩ or higher		
RGB/Component	RGB/Component	BNC x 3, 0.7 Vp-p ±3 dB (Sync on Green 0.3 Vp-p, negative: RGB) (75% chrominance standard color bar signal: Component)		
	Audio	Mini jack x 1, -5 dBu 47 kΩ or higher		
Ext.sync	BNC x 1, 0.3 to 4 Vp-p ± bipolarity ternary or negative polarity binary			
SDI	HD-SDI/D1-SDI: BNC x 2 (HD and D1 are automatically detected) Sampling frequency D1-SDI:Y/R-Y/B-Y 13.5 MHz, HD-SDI:Y/PB/PR 74.25 MHz Quantization 10 bits/sample	D1-SDI: BNC x 2, Sampling frequency :Y/R-Y/B-Y 13.5 MHz, Quantization 10 bits/sample	—	
Remote	Parallel remote	Modular connector 8-pin x 1(Assignable)		
Output				
Line A	Composite	BNC x 1, Loop-through, with 75 Ω automatic termination		
	Y/C	4-pin mini-DIN x 1, Loop-through, with 75 Ω automatic termination		
Line B	Composite	BNC x 1, Loop-through, with 75 Ω automatic termination		
Monitor output	HD-SDI/D1-SDI: BNC x 1, Output signal : amplitude 800 mVp-p ±10%, Output impedance : 75 Ω unbalanced	D1-SDI: BNC x 1, Output signal amplitude : 800 mVp-p ±10%, Output impedance : 75 Ω unbalanced	—	
Audio output	Mini jack x 1, Loop-through			
Headphones output	Mini jack x 1(Monaural), Loop-through			
Speaker output	0.5 W (Monaural)			
General				
Power Consumption	Monitor : Approx. 24 W, With AC Adaptor : Approx. 28 W	Approx. 16 W, With AC Adaptor : Approx. 22 W	Approx. 15 W, With AC Adaptor : Approx. 20 W	
Power requirement	AC 100 to 240 V, 50/60 Hz, 0.82 A, DC 12 V 2.2 A, Rechargeable Battery Pack	AC 100 to 240 V, 50/60 Hz, 0.82 to 0.42 A, DC 12 V 1.6 A, Rechargeable Battery Pack	AC 100 to 240 V, 50/60 Hz, 0.82 to 0.42 A, DC 12 V 1.5 A, Rechargeable Battery Pack	
Operating Temperature	0 to 40 °C			
Operating Humidity	30 to 85 % (No condensation)			
Operating/Storage/Trans. Pressure	700 to 1060 hPa			
Storage & Transport Temperature	-20 to 60 °C			
Storage & Transport Humidity	0 to 90 %			
Dimensions (W x H x D)	Approx. 216 x 206 x 136.1 mm (8 5/8 x 8 1/8 x 5 3/8 inches)			
	Approx. 216 x 230 x 159.5 mm (8 5/8 x 9 1/8 x 6 3/8 inches)			
	Approx. 216 x 230 x 210 mm (8 5/8 x 9 1/8 x 8 3/8 inches)			
Mass	Approx. 3.0 Kg (6 lb 10 oz)	Approx. 2.9 Kg (6 lb 6 oz)	Approx. 2.8 Kg (6 lb 3 oz)	
	With the supplied stand	Approx. 3.2 Kg (7 lb 1 oz)	Approx. 3.1 Kg (6 lb 13 oz)	Approx. 3.0 Kg (6 lb 10 oz)
	With the supplied stand and AC adaptor	Approx. 3.9 Kg (8 lb 10 oz)	Approx. 3.8 Kg (8 lb 6 oz)	Approx. 3.7 Kg (8 lb 3 oz)
Supplied Accessories	AC adaptor (1), AC Cord (1), AC plug holder (1), Operating instructions (1), CD-ROM (1), Warranty card (1), Using the CD-ROM Manual (1)			

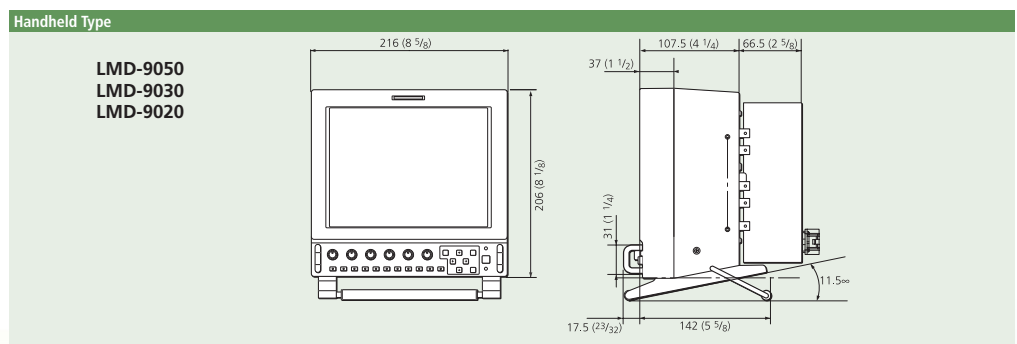

Unit: mm (inches)

Specifications

Multi-display Type



Picture Performance			
Type	a-Si TFT Active Matrix		
Resolution	480 x 234 pixels	320 x 234 pixels	480 x 234 pixels
Picture Size (H x W) (Viewable area) (Diagonal)	Approx. 154.1 x 86.6 mm (Approx. 6 1/8 x 3 1/2 inches) (Approx. 7 inches (176.7 mm))	Approx. 113.3 x 84.7 mm (Approx. 4 1/2 x 3 3/8 inches) (Approx. 5 5/8 inches (141.5 mm))	Approx. 82.1 x 61.8 mm (Approx. 3 1/4 x 2 1/2 inches) (Approx. 4 1/8 inches (102.8 mm))
Aspect	16:9		4:3
Colors	Full color		
Viewing Angle	40°/65°/65°/65° (typical) (up/down/left/right contrast>10:1)	50°/30°/50°/50° (typical) (up/down/left/right contrast>10:1)	
Input/Output			
Composite			
Input	BNC (x 2), 1.0 Vp-p ±2 dB, sync negative	BNC (x 3), 1.0 Vp-p ±2 dB, sync negative	BNC (x 4), 1.0 Vp-p ±2 dB, sync negative
Output	BNC (x2), Loop through, Automatic 75 Ω termination	BNC (x 3), Loop through, Automatic 75 Ω termination	BNC (x 4), Loop through, Automatic 75 Ω termination
OPTION IN	D-sub 9pin (x2)	D-sub 9pin (x3)	D-sub 9pin (x4)
Remote			
Parallel	Modular 8 pin (x2)	Modular 8 pin (x3)	Modular 8 pin (x4)
General			
Power Consumption	Maximum: Approx. 26 W (with 2 x BKM-320D) Standard: Approx. 23 W (without optional input adaptor)	Maximum: Approx. 28 W (with 3 x BKM-320D) Standard: Approx. 22 W (without optional input adaptor)	Maximum: Approx. 26 W (with 4 x BKM-320D) Standard: Approx. 18 W (without optional input adaptor)
Power requirement	12V DC (with the supplied AC power adaptor), AC power adaptor:AC 100 to 240 V, 50/60 Hz		
Peak inrush current	(1) Power on, current probe method:57A (230V)	(1) Power on, current probe method:55A (230V)	(1) Power on, current probe method:53A (230V)
	(2) Hot switching inrush current, measured in accordance with European standard EN55103-1:8A (230V)		
Operating Temperature	0 to 35°C (32 to 95°F)		
Operating Humidity	30 to 85 % (no condensation)		
Storage & Transport Temperature	-10 to 40°C (14 to 104°F)		
Storage & Transport Humidity	0 to 90 %		
Operating / Storage / Trans. Pressure	700 hPa to 1060 hPa		
Dimensions (W x H x D)	482 x 133 x 47 mm (19 x 5 1/4 x 1 7/8 inches)*	482 x 133 x 47 mm (19 x 5 1/4 x 1 7/8 inches)*	482 x 88.1 x 47 mm (19 x 3 1/2 x 1 7/8 inches)*
Dimension including AC adaptor and BKM-320D	482 x 133 x 116 mm (19 x 5 1/4 x 4 5/8 inches)	482 x 133 x 116 mm (19 x 5 1/4 x 4 5/8 inches)	482 x 88.1 x 116 mm (19 x 3 1/2 x 4 5/8 inches)
Mass	Approx. 2.3Kg (Approx. 5 lb 1 oz)**	Approx. 2.3Kg (Approx. 5 lb 1 oz)**	Approx. 1.9Kg (Approx. 4 lb 3 oz)**
Supplied Accessories	AC power adaptor (1), AC Power Cord (1), AC plug holder (1), Screws for AC adaptor holder (2), Operating Instructions (1), Warranty Card (1)		

* without the projection parts ** Excluding supplied accessories.

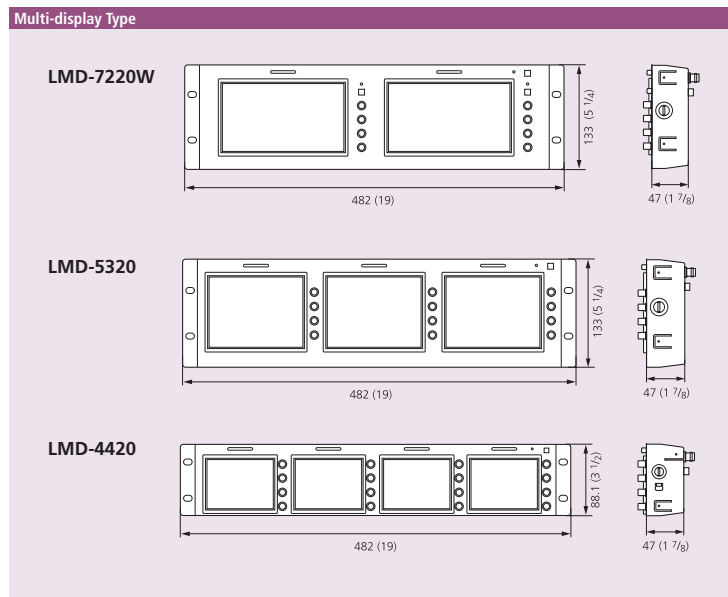

Unit: mm (inches)



SONY

SONY



Distributed by

©2007 Sony Corporation of Hong Kong Ltd. All rights reserved.
Reproduction in whole or in part without permission is prohibited.
Features and specifications are subject to change without notice.
All non-metric weights and measurements are approximate.
Images on monitors are simulated.
Sony, ChromaTRU and LUMA are trademarks of Sony Corporation.
VESA is a trademark of the Video Electronics Standards Association.
All other trademarks are the property of their respective owners.